

电容范围可供选择，从 3PF 到 120PF

规格

Insulation Resistance 绝缘电阻	10 ⁴ MΩ min
Withstanding Voltage 可抵电压	220V DC
Working Voltage 操作电压	100V DC
Rotational Torque 调动扭力	30~100 gr-cm
Operating Temperature Range 操作温度	-25°C ~ +85°C

同时提供正调、反调系列 6mm 陶瓷可调电容

PART.NO	MIN.CAP P (PF)	MAX.CAP (PF)	TEMP.COEFF PPM/C	Q.FACTOR@ 1MHZ.Cmax	COLOR
CVC(N,R)06-030	1.3 max	3.0 ^{+50%} ₋₀	NP 0±250	>500	BLACK 黑
CVC(N,R)06-050	2.0 max	5.0 ^{+50%} ₋₀	NP 0±250	>500	BLUE 蓝
CVC(N,R)06-100	3.0 max	10.0 ^{+50%} ₋₀	N 450±300	>500	WHITE 白
CVC(N,R)06-200	5.0 max	20.0 ^{+50%} ₋₀	N 750±300	>500	RED 红
CVC(N,R)06-300	6.5 max	30.0 ^{+50%} ₋₀	N 1000±500	>500	GREEN 绿
CVC(N,R)06-400	7.0 max	40.0 ^{+50%} ₋₀	N 1200±500	>300	YELLOW 黄
CVC(N,R)06-500	10.0max	50.0 ^{+50%} ₋₀	N 2200±800	>200	BROWN 啡
CVC(N,R)06-600	12.0 max	60.0 ^{+50%} ₋₀	N 2200±800	>200	BROWN 啡
CVC(N,R)06-900	18.0 max	90.0 ^{+50%} ₋₀	N 2200±800	>200	BROWN 啡
CVC(N,R)06-1200	26.0 max	120.0 ^{+50%} ₋₀	N 2200±800	>200	BROWN 啡

6 ϕ CERAMIC TRIMMER CAPACITORS

陶瓷微調電容器

■ STRAIGHT TYPE 直脚

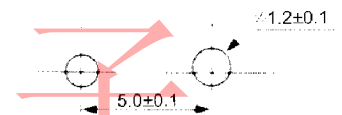
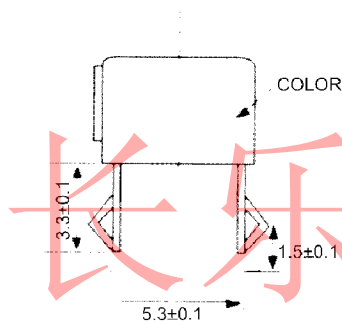
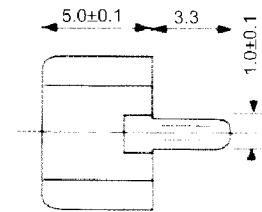
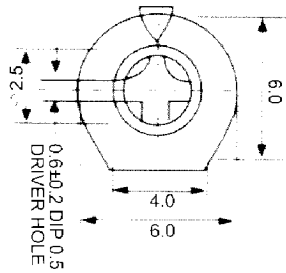

SUGGESTED MOUNTING HOLES

■ REAR ADJUSTING TYPE 反調

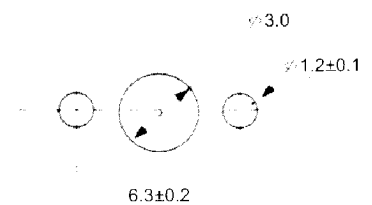
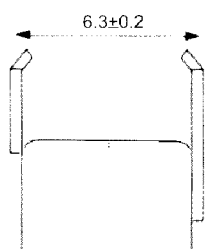
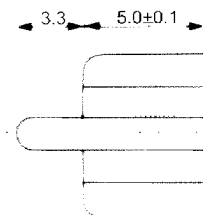
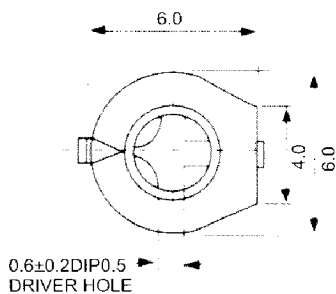

SUGGESTED MOUNTING HOLES
Dimensions in mm (not to scale)